

AIRSOFT



INSTRUCTION MANUAL

Always read through this manual before operation.

Read through this manual before shooting, paying special attention to safe operation.

Failing to do so may cause injury, accidents or damage to the gun.

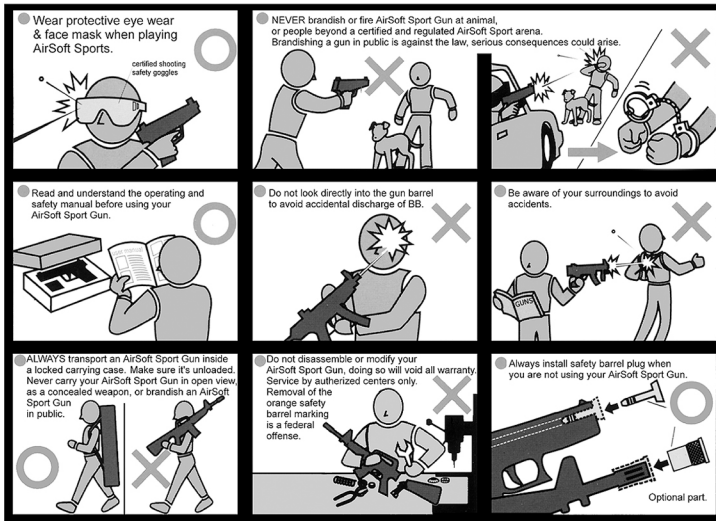

! WARNING !	
18 Years or older	Operation of this air gun is for training purposes only, at legal training facilities. Users will follow all applicable air gun laws and regulations. Sales and usage restricted to persons 18 years of age or older.
Injury Caution	Plastic BB's can reach 50 to 60 meters, and up to 300 fps. Careless shooting and mis-handling may result in severe eye damage and or other injuries. Always wear eye and body protection. Never point or shoot at people or animals.
Please read manual !	Always follow safe handling and precaution listed in the manual. Understand fully all operations of this air gun. Use this air gun with full recognition of it's caution warnings. Use within full compliance of State and local laws.
CHOKING HAZARD keep away from small children.	Contact your Dealer for a replacement manual.

1 COMPONENTS

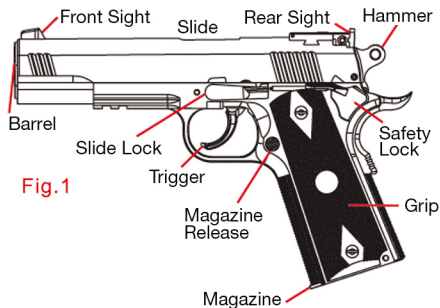

2 SAFETY

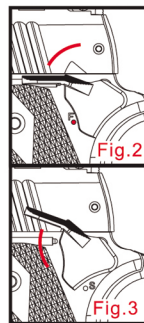

SAFETY OFF: Push down safety lock until the mark "F" appears (Fire). (Fig. 2)

SAFETY ON: Push up safety lock until the mark "S" appears (Safe). (Fig. 3)

When you are not firing the gun, or during storage, always set the selector to the "S" Safe position.

3 INSTALLING THE CO2 CARTRIDGE

A. Always point the pistol's muzzle at a safe direction and make sure the safety is on the "S" Safe position.

B. Use one hand to hold the magazine's bottom and the other hand to hold the grip. Press the magazine release button and slide the magazine out from the grip. (Fig.4) Do not let the magazine fall out, which may cause damage.

C. Turn the knob counterclockwise until the space is sufficient to install a CO2 cartridge (Fig. 5)

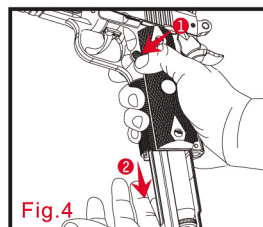

D. Install a CO2 cartridge into the magazine and position it. (Fig. 6)

E. Turn the knob in a clockwise direction fully, to pierce the CO2 cartridge. (Fig. 7)

F. The magazine is now ready for use. Replace the magazine into the gun, until a "Click" is heard, and it is locked into place.

G. To remove a used, CO2 cartridge, reverse the process.

WARNING !

Keep hands and face away from escaping CO2 gas. Gas may cause frostbite if allowed to contact skin.

CO2 cartridges may explode at temperatures above 120°F (48.9°C). Do not mutilate or incinerate cartridges. Do not expose them to heat or store CO2 cartridges at temperatures above 120°F (48.9°C).

Use only CO2 cartridges which are the 12 gram size.

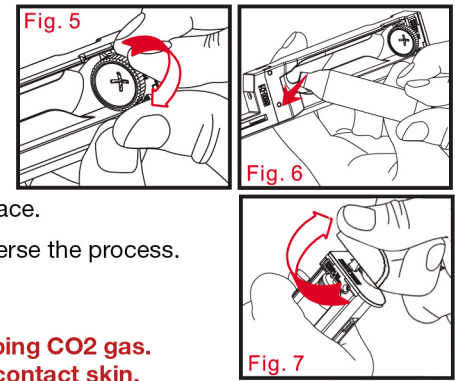

4 LOADING THE BB'S AND FIRING

A. Pull down the BB follower on the side of the magazine all the way down and lock it into the groove. (Fig. 8)

B. Load the BB's into the port, approximately 16 BB's. (Fig. 9) Do not overload.

C. Pull the slide back fully and return to original position, to load the first shot.

D. Set the safety to "F" Fire. The gun is ready to fire.

E. To fire, pull the trigger. Once the last BB has been shot, repeat BB loading instructions until CO2 cartridge is empty.

F. After shooting is complete, set the safety to "S" Safe position.

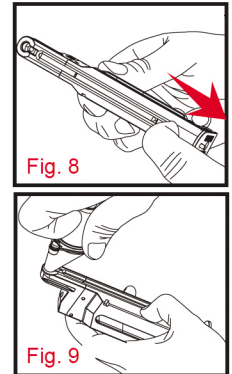

WARNING !

Only use High Quality TSD Precision BB's. Use of sub-quality BB's may damage your gun and will void the Warranty.

5 ADJUSTING THE HOP-UP

A. Pull the slide back and flip up the slide lock to lock the slide open. (Fig. 10)

B. Apply the included tool to adjust the Hop Up (Fig. 11). Adjust the Hop Up to obtain the straightest, longest trajectory.

C. The screw level should not be lower than the external column surface, otherwise, it will get stuck and damage the gun. (Fig. 12)

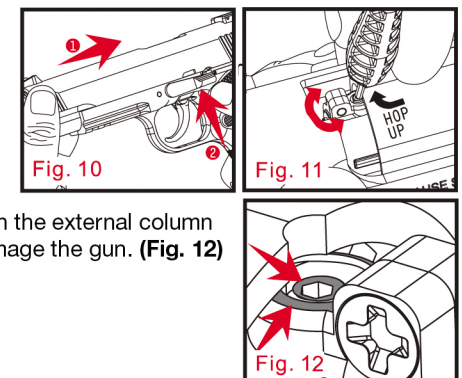

6 SETTING THE SIGHT

A. Make horizontal (right / left) adjustment. (Fig. 13)

B. Make vertical (up / down) adjustment. (Fig. 14)

Note: The best-aiming condition is when the rear sight, front sight and target are aligned in a straight line.

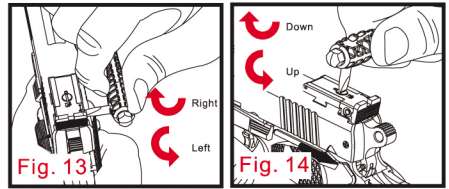

7 EXPLODED VIEW

