

AIRSOFT

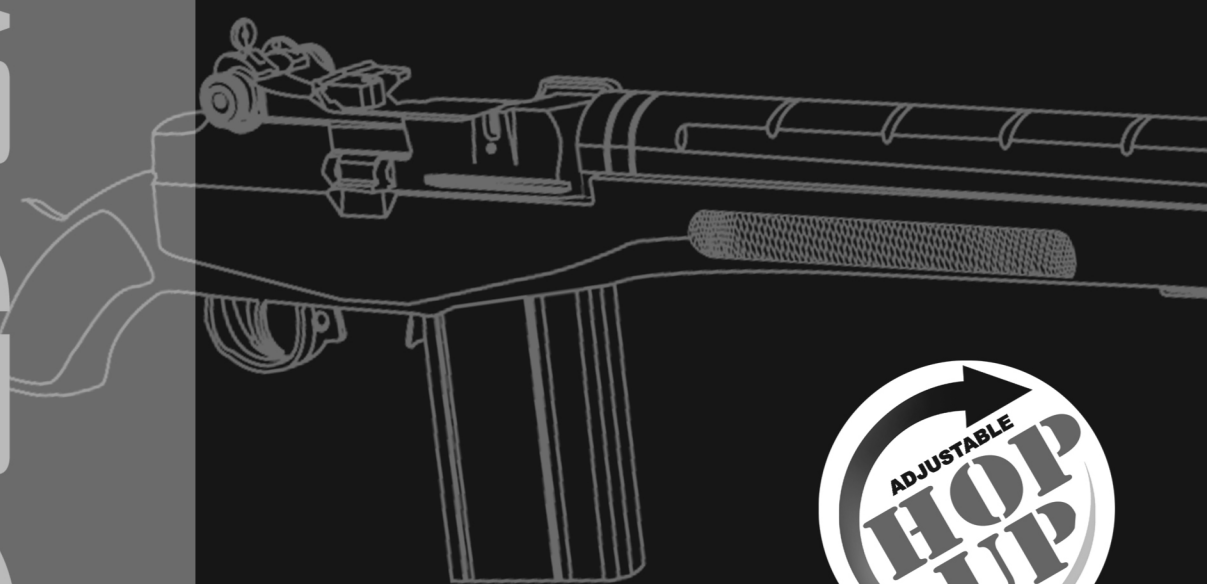

STEEL



**INSTRUCTION
MANUAL**

WARNING

Always read through this manual before operation!

Read through this manual before shooting, paying special attention to safe operation!

Failing to do so may cause injury, accidents, or damage to the gun!

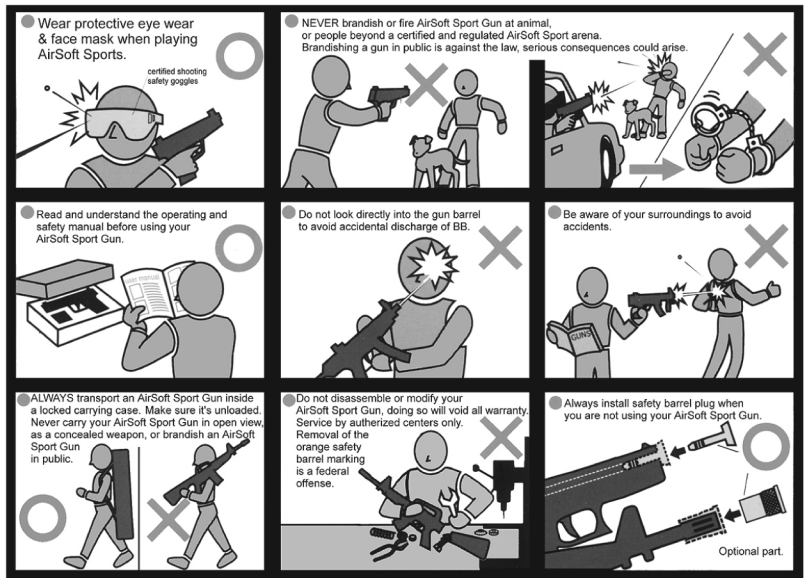

WARNING	
 18 Years or older	Operation of this air gun is for training purposes only, at legal training facilities. Users will follow all applicable air gun laws and regulations. Sales and usage restricted to persons 18 years of age or older.
 Injury Caution	Plastic BB's can reach 50 to 60 meters, and up to 300 fps. Careless shooting and mis-handling may result in severe eye damage and/or other injuries. Always wear eye and body protection. Never point or shoot at people or animals.
 Please read manual!	Always follow safe handling and precautions listed in the manual. Understand fully all operations of this air gun. Use this air gun with full recognition of it's caution warnings. Use within full compliance of State and local laws.
CHOKING HAZARD Keep away from small children.	Contact your Dealer for a replacement manual.

COMPONENTS

- | | |
|-------------------------|------------------|
| 1. Flash Suppressor | 9. Magazine |
| 2. Suppressor Lock | 10. Bolt Stop |
| 3. Front Sight | 11. Rear Sight |
| 4. Outer Barrel | 12. Safety Lever |
| 5. Gas Cylinder Plug | 13. Trigger |
| 6. Front Swivel | 14. Rear Swivel |
| 7. Hand Guard | 15. Stock |
| 8. Hand Guard Rear Band | |

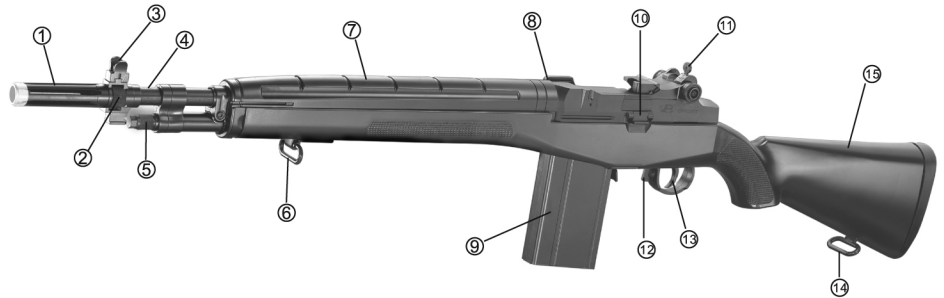

1 SAFETY SETTING (Always set the safety lever to safe position before firing)

● SAFETY setting

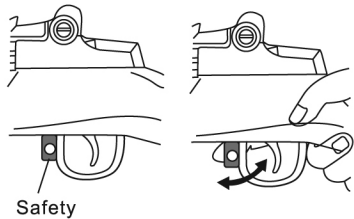

Safety

When you are not firing the gun or during storage, **always** set the selector to the **Safe** position and attach the protective cap to the muzzle.

● SAFETY release

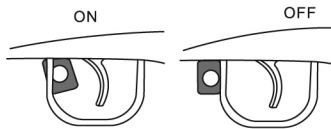

When the safety lever is set to the "On" position, the trigger will not move. Please do not pull the trigger, otherwise you may damage the gun.

When the safety lever is set to the "Off" position, it is ready for shooting.

The gun will fire when the trigger is pulled.

2 LOADING BB'S INTO AND SETTING THE MAGAZINE

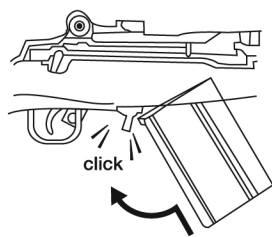

● Installation

Always set the magazine upwards. First hook the hook in the front of the magazine and then press in the rear of the magazine until a sound of "click" is heard.

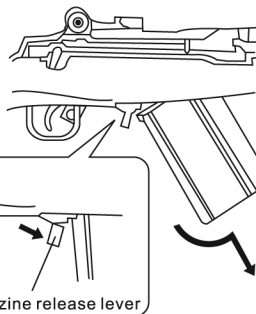

● Removing the Magazine
Press the magazine release lever to remove the magazine.

CAUTION

Be sure that the safety lever is set to the Safety position and don't place your finger on the trigger except when you are ready for shooting.

● Load BB'S into Speedloader

Open the Speedloader Cap. Insert 6mm BB'S into the Speedloader.

Press the Rod Release button to release the Spring Rod.

Insert Speedloader into the magazine and pump Spring Rod until magazine is full.

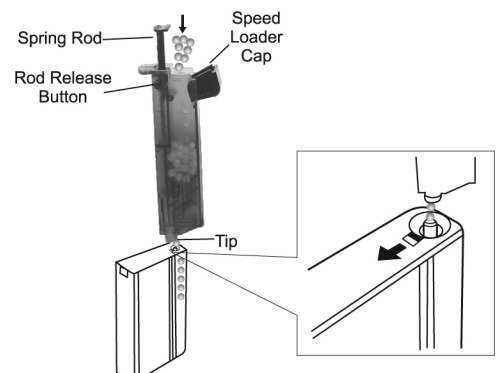

3 OPERATION

- The bolt retracts at the same time the operating rod is pulled.

To fire the gun, pull back Operating Rod **all the way back**, until a “click” is heard, then release.

Make sure the Safety release is in “Off” position. The gun is now ready for firing.

Pull Trigger.

Replace Safety release to “On” position when gun is not in use.

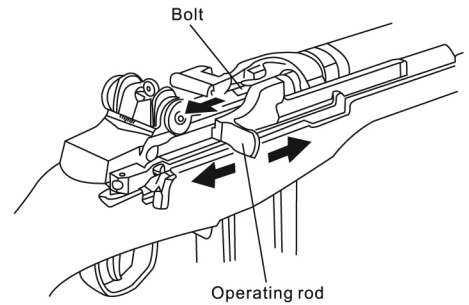

WARNING-CAUTION

Be careful not to put your finger in the bolt as it will close quickly when the operating rod is released.

4 SETTING THE OPEN SIGHT

- Elevation adjustment

Turning counterclockwise lowers the bullet hitting point.

Turning clockwise raises the bullet hitting point.

- Windage adjustment

Turning clockwise moves the bullet hitting point to the left.

Turning counterclockwise moves the bullet hitting point to the right.

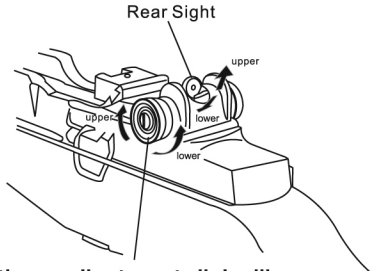

Turning the elevations adjustment dial will move the bullet hitting point to the upper or lower.

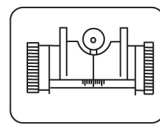

Turning the windage adjustment dial will move the bullet hitting point to the left or right.

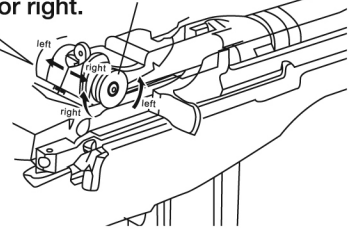

5 HOW TO AIM/HOLD

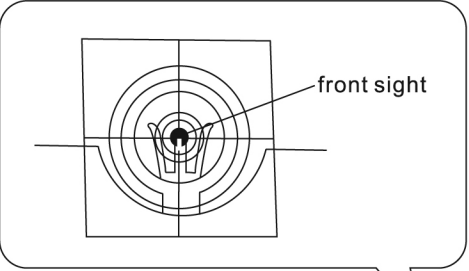

- How to Aim.

Look through from the front sight to the hole of the rear sight, and aim at the center of the target

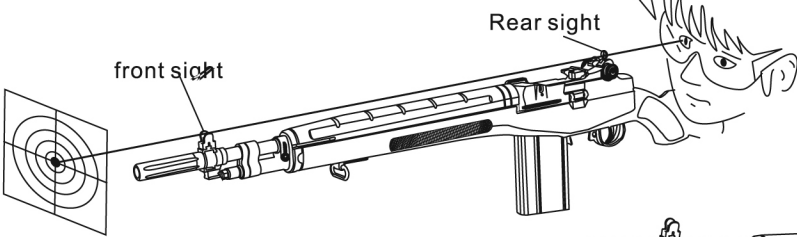

- How to hold.

Press the butt plate against slightly inside of the shoulder joint and put your cheek on the stock. Aim at the center of the target as shown in the above figure.

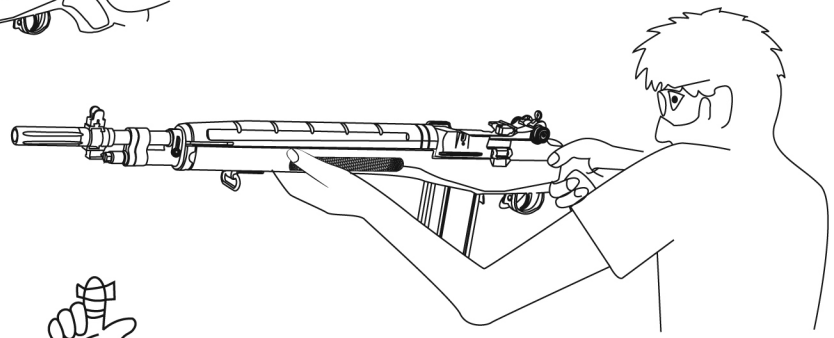

- Be careful not to put your fingers in the moving parts.



6 MAINTENANCE

• Maintenance when bull speed becomes low

1. Apply Oil as shown below, using the cleaning road and oiled cotton cloth. Insert cleaning rod into barrel.
2. After completing cleaning, use the cleaning rod (with cotton) as shown below to Remove excess oil.

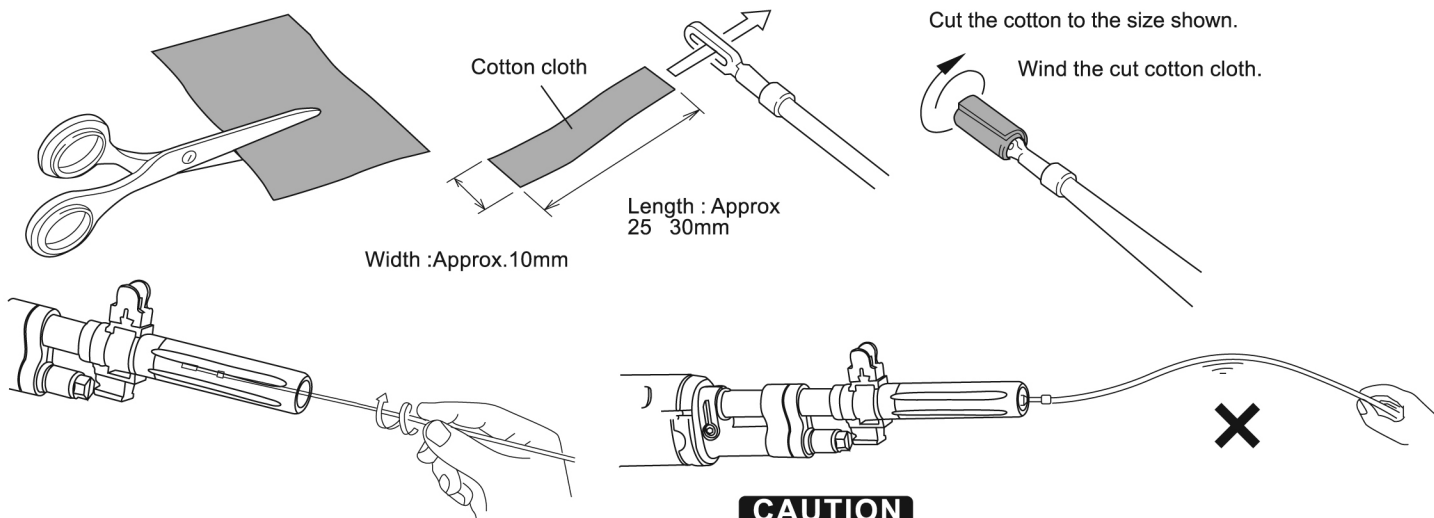

- Always turn the hop up lever completely down before inserting Cleaning Rod.
- It is difficult to insert the rod if you hold the rod at the end.

• Removing Clogged Bullets (Set the Safety button to ON and remove the magazine beforehand.)

1. Remove the Magazine
2. Turn the hop up dial completely down and insert the Cleaning Rod from the lead edge of the barrel.

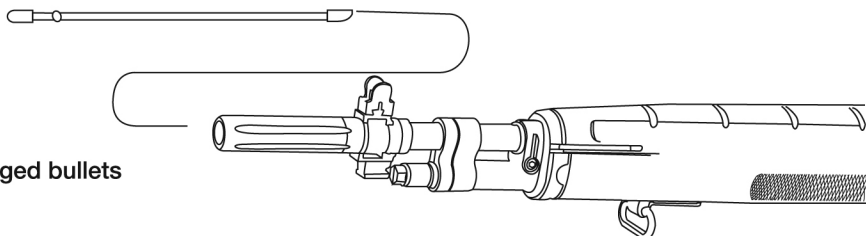

3. Be careful so that the angled part of the Cleaning Rod faces down, and remove clogged bullets

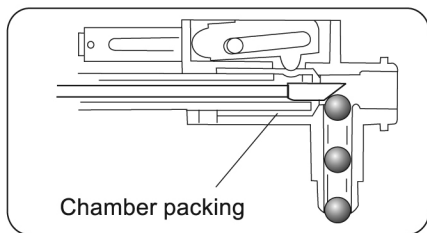

Make sure to clean the barrel chamber whenever bullets are removed.

- When bullets are clogged, immediately stop operation, Remove clogged bullets and then restart operation of the air gun. (If operation is continued with bullets being clogged, the mechanism may be damaged.)
- Be careful during maintenance, as the inside chamber is precisely designed and can be damaged easily. Use of a hard brush may damage the hop chamber packing.

! WARNING !	
18 Years or older	<ul style="list-style-type: none"> • Operation of this air gun is for training purposes only, at legal training facilities. Users will follow all applicable air gun laws and regulations. Sales and usage restricted to persons 18 years of age or older.
Injury Caution	<ul style="list-style-type: none"> • Plastic BB's can reach 50 to 60 meters, and up to 300 fps. Careless shooting and mis-handling may result in severe eye damage and or other injuries. Always wear eye and body protection. Never point or shoot at people or animals.
Please read manual !	<ul style="list-style-type: none"> • Always follow safe handling and precautions listed in the manual. Understand fully all operations of this air gun. Use this air gun with full recognition of it's caution warnings. Use within full compliance of State and local laws.
CHOKING HAZARD Keep away from small children.	
Contact your Dealer for a replacement manual.	



www.airsoftSD.com